

ah!38 Tilt & Turn





ah!38 Tilt & Turn

introduction

ah!38 Tilt & Turn is a system that can be opened in two positions: swinging, wherein the opening is performed on the upper part and a tilting position that consists of a side opening. It allows for good acoustic and thermal insulation performance, while guaranteeing a good level of safety. It is designed to be aesthetically on par with the other opening systems.

ah! 38 Tilt & Turn est un système qui peut être ouvert dans deux positions: oscillant, dans lequel l'ouverture est réalisée sur la partie supérieure et une position d'inclinaison qui consiste en une ouverture latérale. Cela permet de bien performances d'isolation acoustique et thermique, tout en garantissant un bon niveau de sécurité. Il est conçu pour être esthétiquement à égalité avec les autres systèmes d'ouverture.

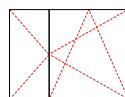
opening system

	tilt and turn	side hung	french casement	vertical bottom hung	horizontal bottom hung
					
monorail	•	•	•	•	•
birail	•	•	•	•	•

main dimensions up to

max. leaf height hauteur max. du vitrage	2800mm	
max. leaf width longueur max. du vitrage	1800mm	
max. weight poids max.	up to 170kg / glass pannel	
max. glazed area surface max. du vitrage	double glazing double vitrage	up to 4m ²
	triple glazing triple vitrage	up to 4m ²
glass thickness épaisseur du vitrage	38mm	

performance up to

light transmission transmission lumineuse	up to 98%	
thermal coefficient coefficient thermique	double triple	Uw = 1.165W/m ² .K (Ug = 0.7W/m ² .K) Uw = 0.816W/m ² .K (Ug = 0.47W/m ² .K)
security sécurité	RC2 / WK2	
sound insulation indice d'affaiblissement acoustique	41dB	
water tightness résistance à l'eau	up to Class E900	
air tightness résistance à l'air	up to Class 4	
wind tightness résistance au vent	up to Class C3	



House in Junqueira | Lisbon, Portugal
 António Costa Lima Arquitectos
 © Francisco Nogueira



Standard



Premium
 Álvaro Siza Vieira

construction

finishes finitions

All **panoramah!**® System series guarantee that the following finishes are carried out by duly certified entities, according to QUALICOAT and QUALANOD directives: Lacquered RAL, Lacquered PVDS, Anodized, Satin, Polished and Repellent.
 Tous les traitements de surface **panoramah!**® sont certifiés selon les directives QUALICOAT et QUALANOD: Laquage RAL ou PVDS, anodisation naturelle ou couleur, satinée, polie ou brossée.

add-ons add-ons

Integrated Blind system / heated glass / intrusion detectors
 Système de store intégré / vitrage chauffé / détecteurs d'intrusion

motorisation automatization

Our motorisation system can be adapted to all sliding or opening systems allowing a full integration with minimum interference in architectural design with a simplified and very quiet opening.
 Notre système de motorisation peut être adapté à tous les systèmes coulissants ou ouvrants, permettant une intégration complète avec un minimum d'interférences dans la conception architecturale avec une ouverture simplifiée et très silencieuse.

ah!38 Tilt & Turn

tilt & turn common sections | tilt & turn sections communes

1:3

scale / échelle

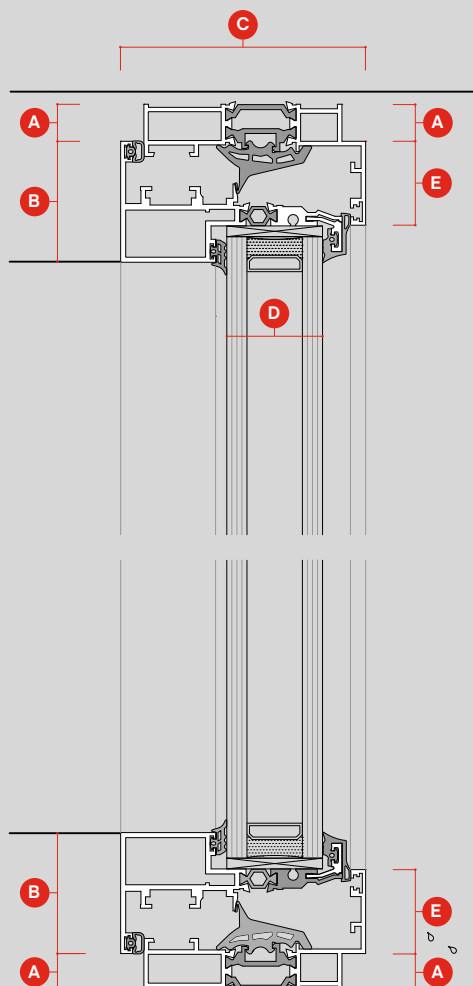
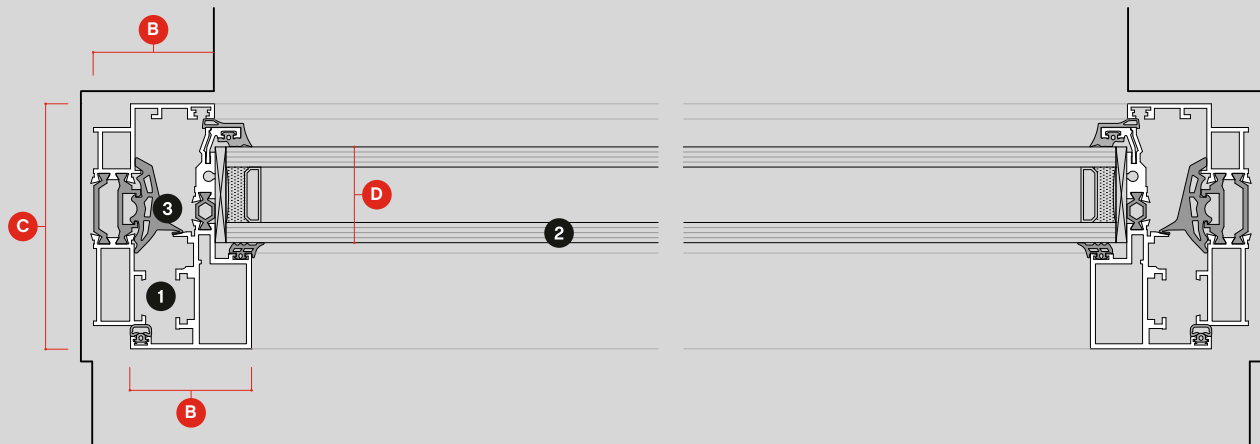

dimensions

- A** 15mm
 - B** 48mm
 - C** 97mm
 - D** 38mm
 - E** 33mm
- 1** main frame
 - 2** glass
 - 3** polyamide

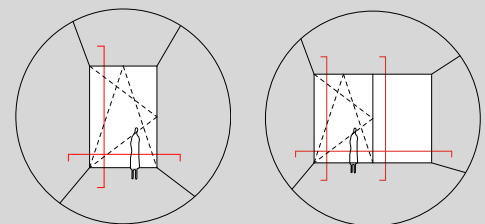

ah!38 Tilt & Turn

tilt & turn common sections | tilt & turn sections communes

1:3

scale / échelle

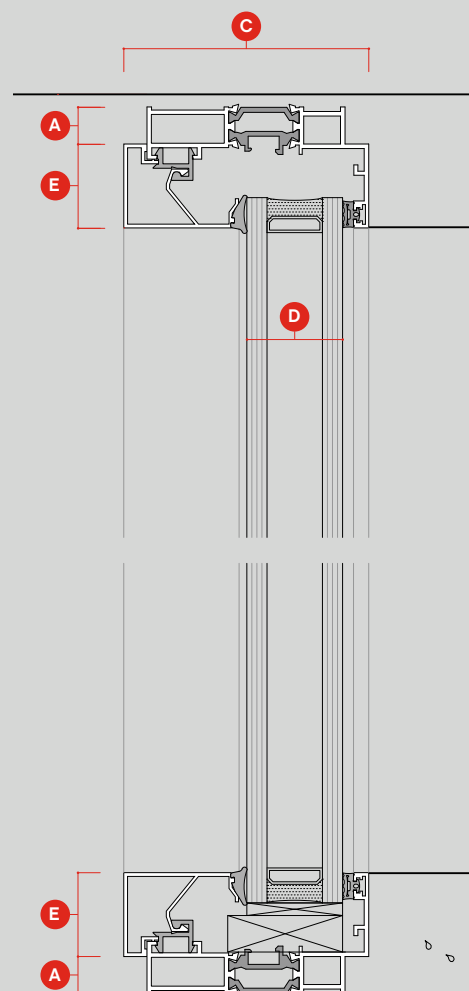
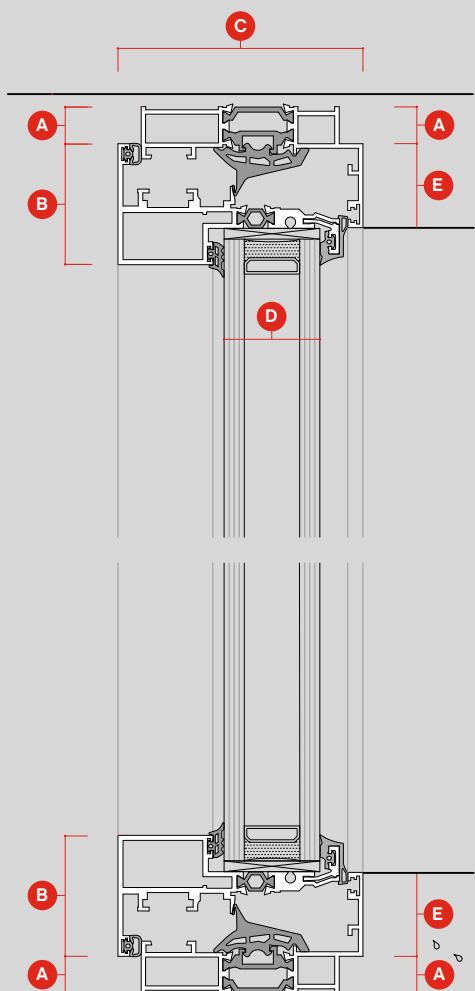
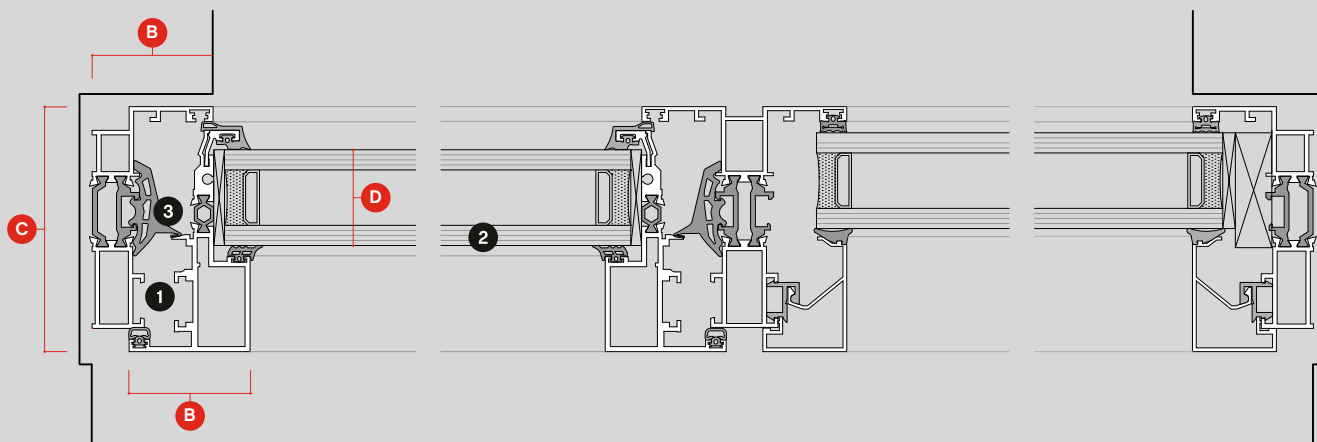

we build ah!



unlimited perspective sa
ch philibert-de-sauvage 37
1219 chatelaine
switzerland

p. +41 21 804 1700
f. +41 21 804 1709

info@panoramah.com
www.panoramah.com

facebook
www.facebook.com/panoramah.ch/

instagram
www.instagram.com/_panoramah_/